



Carnivore Damage Prevention News

No 5 / May 2002

Notes from the Editors

This whole issue of the CDPNews is focused on electric fencing, a promising non-lethal predator exclusion system, which in fact also protects the predator. Nowadays, livestock can effectively be protected by shepherds with the help of livestock guarding dogs, particularly during summer time. Nevertheless, especially in Western Europe, this method is very expensive and is only financially viable for large flocks. Moreover, in spring and autumn, these large flocks are often dispersed in smaller ones and kept in enclosures in which livestock guarding dogs are often absent. In addition, a lot of livestock breeders don't want to integrate livestock guarding dogs into their flocks, arguing they will disturb the stock or, that accepting a dog is also accepting the predators. Therefore we have to test and provide adapted preventive measures like electric fences for these people to protect their livestock.

There is a lot of knowledge about electric fencing and to some extent, on large carnivore-proof electric fences, depending on the species to be exclude. For example, John Bourne from Alberta Canada presents an electric fence system protecting livestock effectively from coyote predation. However, we need further tests on the effectiveness of electric fencing against large carnivores like the ones carried out in Sweden and reported by Maria Levin.

A lot of CDPNews readers - more than 400 at present - are not necessarily experts in your field. Therefore it is important to share your experience through the CDPNews to avoid them starting from the beginning and making the same mistakes again. The more we contribute to widen the experiences, the more we will be able to recommend adjusted preventive measures to whom it may concern. The latest technology of electric fences, more and more efficient and reliable, will undoubtedly enhance their use to decrease predation, which in turn will protect predators by reducing conflicts with livestock.

The Editors:

Christof Angst; ch.angst@kora.ch

Jean-Marc Landry; landry@vtx.ch

John Linnell; john.linnell@ninatrd.ninaniiku.no

Urs Breitenmoser; Breitenmoser@ivv.unibe.ch

Contents

1. Testing and Implementing the Use of Electric Fences for Night Corrals in Romania
Annette Mertens, Christoph Promberger, Paul Gheorge..... 2
2. How to Prevent Damage from Large Predators with Electric Fences
Maria Levin..... 5
3. Electric Fencing for Predator Protection in Alberta
John Bourne..... 9
4. Electric Fencing and Carnivore Damage Prevention
Anton Vidrih..... 10
5. Operation of Electric Fences: Some Practical Advice
Agnes Dhilly-Delpeche..... 12
6. Fence Systems and Testing of Grounding Systems: Some Practical Advice
Christof Angst 14
7. Publications and Reviews..... 17
8. Market place..... 18
9. Meetings of interest..... 19
11. Damage prevention on the Web..... 19
12. Subscription for CDP News..... 20
13. LCIE card..... 20
14. Impressum..... 20

Testing and Implementing the Use of Electric Fences for Night Corrals in Romania

by

Annette Mertens; annette@clcp.ro
Christoph Promberger; christoph@clcp.ro
Paul Gheorge; paul@clcp.ro

In Romania, significant populations of large carnivores still coexist with livestock: in the Carpathian mountains, with a surface of approximately 70,000 km² there are about 5500 bears, 3000 wolves, 2000 lynx, 4.5 million sheep and 1.5 million cattle. In Romania, traditional damage prevention methods are still well preserved: in the evening livestock is always brought back to the livestock camp and is penned. Furthermore they are permanently guarded by shepherds and livestock guarding dogs. Despite these measures, damage still occurs due to depredation by wild predators. Results from our research over the last four years indicate that wolves and bears killed round 1.5% of the sheep present in the mountain livestock camps, an average of about seven sheep per camp.

Electric fencing has been successfully used in many places to prevent wildlife damage to human activities. Thus, we decided to test this method in Romania and implement its use in the livestock camps in our study area. Since 1999 we have installed fences around the night-time pens (corrals) at

eleven different livestock camps (Tab. 1). We have chosen the camps according to the amount of damage they have experienced so far, the interest of the livestock breeder for testing this method and his reliability. In summer 2001 we distributed the fences throughout our study area of about 1000 km². In addition, we installed two fences in two counties distant from our study area.

Two of the shepherds have been using the fences for over a year. Now, they put it up only when they have animals in camp. The shepherds of two other camps were not convinced of this technique and so they did not use the fence. All the others used it for varying periods of time. Most of them were satisfied with the fence as a protection method. Four of the livestock raisers have used the fence also during last winter and are already self-sufficient in its use.

Description of the fences

We use "Gallagher" mobile fencing with five wires. Each wire contains six rustproof steel strands and three copper strands, interspersed with plastic strands. This makes the wire more flexible. The gate is made of five easily extendable metal springs (one for each wire). The posts are of plastic with iron spikes that are driven into the ground. They are 1.6 m high. The wires are spooled onto special plastic reels that make it very easy and fast to stretch the wire when the fence is set up. The reels are fixed onto metal posts that are set up near the gate. The

Tab. 1: Fences that were installed at livestock camps from summer 1999 to fall 2001. The number of kills refer to the period in which the sheep were penned in the fence.

Camp	Date installed	Days used	Kills	Predator	Days not used ¹	Kills when not used ²
<i>Gircin</i>	October 1999	185	0		-	-
<i>Prejmer</i>	November 1999	14	0		-	-
<i>Vurpar</i>	November 2000	150 ³	0		-	-
<i>Musoiu</i>	01.04.01	183 ³	1 sheep	wolf	0	-
<i>Ohaba</i>	01.05.01	86	0		66	18
<i>Enescu</i>	15.05.01	0	0		152	47
<i>Pruna</i>	11.06.01	111 ³	0		41	0
<i>Ciuma</i>	18.06.01	104 ³	1 sheep	bear	48	2
<i>Pietre</i>	27.06.01	41	0		111	7
<i>Coja</i>	27.06.01	0	0		152	4
<i>Vladusca</i>	21.07.01	47	0		105	6
Total		839	2		675	84
Average		76.2	0.18		84.4	12

¹ The days in which the fence was in use was detracted from 152, the total number of days of the average grazing season.

² All the days in which the fences were not installed and periods during day, when sheep were not penned.

³ The fences are still in use. The cut off date for "days in use" was 30th of September 2001.

wire is then unrolled from the reel simply by pulling it, and, at the other end of the fence (at the opposite side of the gate), it is fixed to the gate. In this way, the electricity is led from the wire directly through the gate. The posts have several slots for the wire at different heights. Thus, it is possible to choose different spacings for the wires (see www.gallagher.co.nz Gallagher New Zealand; www.gallaghereurope.com, Gallagher Europe or www.gallagherusa.com, Gallagher USA for further information).

The fence that has been used for the longest time has been out since 1999. We have not noticed any sign of deterioration in the components. The fences can probably be used for many years if they are properly maintained.

Power supply

We use Gallagher 12V impulse generators (PowerBox 200) powered by normal car batteries. They have an impulse energy of 1.2 joules and can generate impulses in fences up to 10 km long (without vegetation). They produce two different impulse frequencies: 1 impulse/sec and 1 impulse/3 sec. The generator and the battery are placed in a special plastic box. This allows the device to be left near the fence without being damaged by the weather, animals, etc. The generated impulses can reach 6000V, according to the strength of the

impulse generator, the grounding system, and the amount of vegetation along the fence. We try to maintain impulses of at least 5000V. The car batteries can be charged by a simple charger connected to a 220V source or connecting the battery to a running car. In camps, lacking the ability to charge the batteries, we have installed solar panels that are directly connected to the battery and the generator. Our generators can produce impulse in 1 to 10 km of wire, depending upon the amount of vegetation along the fence.

Setting up the fence

We place the wires 20-30 cm apart, the lower wires closer to one another than the others. However, we vary the wire-spacing and the height of the highest wire according to the steepness of the terrain and the predator species (wolf or bear) which causes most damage to the camp: where wolves are a bigger danger we tend to concentrate the wires lower to the ground to avoid wolves sneaking through under the lower wires. Where bears are the main problem we set the wires as uniformly as possible. When the fence is on a slope, on the higher side of the slope we put the wire on the highest level to reduce the possibility that an animal jumps in from above. We set the posts at 5 to 10 meter intervals. This also depends very much on the topography: where the



Fig. 1: Electric fence for a night corral installed on a mountain pasture in Romania

ground is irregular we put the posts closer in order to be able to follow the contour of the ground as well as possible. In the corners we always put a wooden post, made by the shepherds, on which we place screw-in ring insulators. The wooden posts give the system higher stability. We always check that the wires on the posts have the same spacing as on the plastic posts. We noticed that the shepherd dogs immediately identified differences in the spacing of the wires and passed through. If the vegetation is very high we ask the shepherds to cut the grass under the wires. The wires have to pass without touching the ground or the vegetation in order to avoid power loss along the fence. We used wire rolls of 400 m and 200 m length but we rarely used the whole rolls. Most of the enclosures covered 400 m² to 600 m².

The mobile fences we use are appreciated because they can be set up quickly. The first set up of a 400 m fence can take a maximum of 3 hours for two persons. After it has been set up the first time (the various parts are assembled, the insulators are put on the wooden post etc.) two persons can move (take down and set up again) the fence in one hour.

Effectiveness

The 85 camps without electric fences we monitored in the past four years had an average of 7.05 (SD = 9.82) sheep killed per summer. The median value of kills was 4 (lower quartile: 1, upper quartile: 7). The average number of kills is as high as the upper quartile due to the fact that some of the livestock camps suffered very high damage (8 had over 20 sheep killed, 4 had over 30 and 2 over 40). 67 (79%) camps had at least one sheep killed per grazing season. The camps that had electric fences suffered a damage of 0.12 kills per day (Tab. 1) in periods in which the sheep were not penned.

Since we began testing the electric fences, we have recorded three cases in which predators entered an enclosure: in two cases, at the same livestock camp, a bear entered the fence. Here the fence was working with only 3 impulses per minute due to the fact that the battery was not properly charged. In one of these cases a sheep was killed. The third case was of a wolf that managed to enter a fence and attack a sheep. It then became scared of the fence, left the sheep (it was still alive and had to be killed) and left. We don't know how the wolf managed to enter the fence. Overall, there has been a killing frequency of 0.002 kills/day. This is 1.6% of the killing frequency of the same camps when the fences were not used and 2.59% of the killing frequency (0.077 kills/day) in the camps without electric fences. Even if the

damage reported from camps where sheep were not protected by fences would be an overestimation to a certain degree, this can still be considered to be a significant difference.

Problems

According to our observations, sheep and cows learned very quickly to keep away from the wires. After one day of being in the enclosure the animals never approached the wire closer than one meter. Especially sheep seemed to learn from each other to avoid touching the fence. Livestock guarding dogs also never seemed to have problems with this device. After each of them got shocked once they never approached the fence very closely again. One case was reported in which the sheep in the enclosure were frightened (the cause is not known), ran through the fence, and four of them were tangled in the wires. To our knowledge this was the only incident in which the fence caused trouble to the flock. Occasionally, we found batteries discharged and thus the fences were not properly working. However, most of the time the batteries were working properly. The majority of the shepherds have a battery charger at home. Once a week they managed to go home to charge the battery. Alternatively, they can attach the battery to their car to charge. Still, if the use of electric fences were to spread, the batteries might become one of the major problems. Solar panels can easily be used, but they also present some problems: they attract thieves, it is one technology more shepherds have to use properly and solar panels present a further cost. As far as we can see, the fencing system we are using has not shown any particular weaknesses in preventing bear or wolf from attacking livestock. However, problems may arise which we have not noticed so far.

Implementation of the use of electric fences

In Romania the use of electric fences is almost unknown. In the first two years we wanted to test these fences, we managed to set up only two. Most of the shepherds were suspicious of this method. They did not understand why we wanted to give them an electric fence for free. Furthermore, they were not willing to make an effort to learn a new method, and they were scared that their sheep could be killed by the fences. To solve this problem, we organised meetings in spring 2001 to which we invited fifty livestock breeders, as well as the two shepherds that had already used the fences. At the meeting, we demonstrated the use of the fences and gave slide presentations. The two shepherds that had

already used the fences told the others about their positive experience with the fences - they had no losses since they have installed the fence. As a result of these meetings, many livestock breeders became quite interested in using this device. In summer 2001, we managed to install all the fences at livestock camps. Through our media activities, people from other areas in Romania were informed of our activities, and we even received a request for an electric fence from a shepherd located far from our study area. At present, we can't meet the huge demand for electric fences. Thus, our next step will be to find a manufacturer to produce fences within Romania that can be sold at prices affordable to Romanian livestock raisers.

Does the reduction of damage pay for the costs of electric fences?

Our experiments have shown that the use of electric fences can help to reduce the damage to livestock caused by large carnivores. However, an electric fence is not a cheap measure. On the western European market, a good quality fence of 400 m length with five wires can cost US\$ 500.- to 800.-. This is much too expensive to be affordable for Romanian livestock breeders. However, we are interested in knowing how much an electric fence could cost in order to be profitable, if it were produced more cheaply in Romania.

This year we calculated an average damage at livestock camps of US\$ 260.- per camp. This includes animals killed and the loss of milk production. The damage caused at camps with electric fences was US\$ 6.70, only 2.59 % of the damage caused at the other camps. According to these calculations, an electric fence that cost approximately US \$ 250.- would be paid for by the reduced loss of livestock in one year.

However, there is one factor influencing these calculations: the person in charge of the livestock camp never has to pay for all the damage caused by large carnivores. He has to pay only a part of the damage. The animal owners bear the rest of the loss. Thus, nobody suffers such a high loss that it would be profitable to pay a high price for an electric fence. On the other hand a fence like the one we tested can work for many years if it is properly maintained. Thus, the investment for an electric fence would probably be profitable for a person who owns many animals or who is in charge of a flock for a longer period.

See also the *Carpathian Large Carnivore Project* on: www.clcp.ro

How to Prevent Damage from Large Predators with Electric Fences

by

Maria Levin; maria.levin@nvb.slu.se

Swedish experiences with electric fences

The Wildlife Damage Center / Viltskade center (WDC) in Sweden continually tries to develop and evaluate preventative methods against large predators and other protected species. Since the majority of livestock in Sweden are grazed in fenced areas, WDC has put some effort in finding the most efficient fence design to exclude large predators. In 1997 we learnt that electric fences successfully prevented bears from raiding beehives, which is among the most attractive food they can get. At that time we tested fences with both three and six wire strands. Both turned out to be "bear safe". Building on this knowledge, this kind of fence (but with four or five wires) has been erected all over the country. There have been few, if any, livestock attacked by large predators within well constructed and maintained "predator-proof fences" in Sweden.

Fence tested with captive lynx

These fences seem to effectively exclude bears and wolves in Sweden, but when it comes to lynx people have been more doubtful. Some reports of lynx that had jumped between the wires led us to set up a study in cooperation with Swedish zoological parks in the fall of 2001. So far we have only results from experiments with lynx but we plan to perform tests with wolves in spring and summer 2002.

Four types of fences were tested:

- a standard non-electric sheep net (woven wires, height 90 cm)
- a sheep net supplied with two electric wires – one on top of the net and one at the bottom (see figure 1)
- an electric fence with three wires (wires on heights of 20, 40 and 70 cm)
- an electric fence with five wires (wires on heights of 20, 40, 60, 85 and 110 cm (see figure 2)

The lynx (one at a time) were kept in an enclosure in which the test fences (two at the time) cut off a corner. Food (roe deer meat) was only supplied on the other side of the test fences. Monitoring cameras that registered and recorded every movement the animals made were installed close to the fences. The results from this study are not yet published, but we

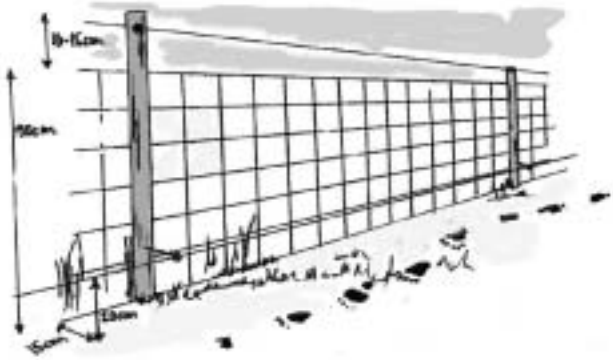

Fig. 1: Sheep net supplied with two electric wires – one on top of the net and one at the bottom.

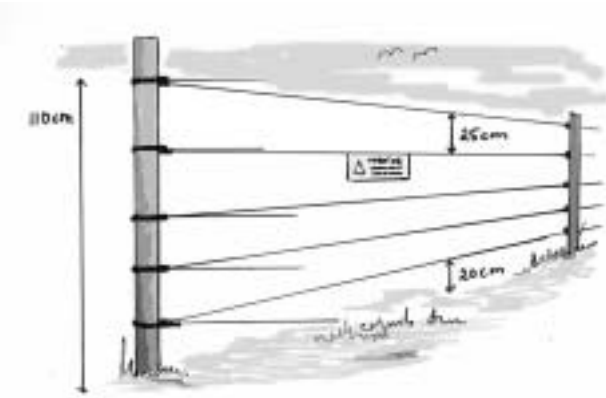

Fig. 2: Electric fence with five wires (wires on heights of 20, 40, 60, 85 and 110 cm above ground).

learnt that the most efficient fences were the sheep net with two electric wires and the electric fence with five wires. The lynx were capable of slipping under the lowest wire if the distance by accident exceeded 20 cm (25 – 30 cm). In some cases they also jumped between two wires if the distance between them was 25 cm or more. The lynx never jumped over any of the fences. So far the results from this study make us believe that lynx might be the most difficult predator to exclude with fencing. Swedish experiences so far reveal that bears and wolves are much more suspicious about electric fences than lynx. The critical point is that the lowest wires are mounted as close as 20 cm to the ground.

Recommended construction of electric fences

Today WDC recommends the two types of fences mentioned above against large predators. We think that they provide a good protection against mainly wolves and bears but in most cases also against lynx. Construction and maintenance of electric fences are the very base condition for success. It pays to invest

in good quality from the start – it lengthens the lifetime of the fence and results in less costs and time of maintenance. We calculate a lifetime of 15 - 25 years for well-kept fences of good quality.

Poles

The refraction poles should be of impregnated wood, with a diameter of 10 - 15 cm. Impregnated wood is lasting much longer in the soil. The poles should be knocked down to a dept below freezing (in Sweden at least 1 m). It is important to stabilize the foundation properly. The distance between the refraction poles depends only on the terrain.

The in between poles can consist of glass fibre, plastic or hard wood like eucalyptus with a diameter of 4-6 cm. The distance between these poles should be about 4 to 8 m, depending also on the terrain. Try hard to get as straight lines as possible that will make the fence much stronger.

Wires

The wires should be smooth and of high-tensile quality and have a good galvanization. A wire of stainless steel is also acceptable but has to be supplemented with a spring so that it does not stretch too much. The diameter of the wire should be 1.4 - 2.5 mm (a coarse wire is more visible but also more expensive and harder to work with). The wires (or net) have to be properly stretched. If they loosen, the risk that animals will jump between them increases. For this reason special wire stretchers should be mounted on the wires. Splicing should be carefully done. Make sure that the wires get attached close to each other to make the resistance as little as possible and to achieve a good conductivity. The distance between the wires should not exceed 20 cm to make sure that lynx don't jump between them. It is also important that the distance between the lowest wire and the ground is not larger than 20 cm. Use five wires for a predator safe fence. Avoid electric cords or ropes as well as twisted wires in permanent fences. They provide less conductivity, are more expensive, and have a shorter lifespan than those recommended above.

WDC recommend against electric nettings if it is not the only practical solution at a place. Experience tells that animals, both domestic from the inside and wild from the outside, have died while struggling to get loose from entangling. The fences can however provide an emergency short-term solution before a permanent fence is mounted, for example in an area newly exposed to predation. In areas where there is a

need to move the farmed animals between different smaller pastures during the season electric nets can also be a solution.

Insulators

The insulators (that hold the wires) must be strong and durable. It pays to choose a good quality from the start. A good insulator should have a distance of at least 20 mm between the wire and the closest part that is not insulated (counted as the surface of the insulator). At corner poles the stress on an insulator is severe. A good (and cheap) solution is to mount pieces of insulation tube around the wire around the pole. The tube should be resistant to UV-light and harsh weather. If a standard sheep net is supplied with wires the wires should be mounted on distance insulators. The distance should be at least 15 cm between the net and the wire.

Earth

It is very important to earth the fence properly. The iron bars that earth the fence must be at least 1 m long. They should be knocked down at a distance of 1-2 m or more from each other. Use three iron bars as a minimum. Adjust the earth connection to the soil conditions. The voltage to the iron bars should be less than 300V.

Energizers

Generally one should choose an energizer with over-capacity to make sure that the voltage is large enough even after rain and when grass might have grown up and bent over the lowest wires. It also makes it possible to extend the fence without changing the energizer. The energizer should supply the wires with at least 4'500V. Feeder cables can overcome long distances between energizer and mains electricity. In Sweden there are some examples of such cables being more than 2 km long. If the energizer cannot be mains operated there are powerful battery-operated energizers available on the market. These batteries can be supplied with solar panels that reduce the work with charging the batteries.

Voltage

Keeping a good control of the voltage is of main importance! This must be done with a voltmeter. Special applications can supply the unit with an alarm system that warns if the voltage gets below a certain level. Lightning conductors that protect the energizer during thunderstorms can also be a good investment.

Maintenance

Maintenance is an absolute condition for an effective predator-proof electric fence. Growing vegeta-

tion that lays against the wires must be cleared up at least once a year. The wires must be kept stretched.

Ground frost, dry earth and snow

To prevent the effect of snow or very dry earth or leaves from functioning as insulators, wires number 2 and 4 (counted from the ground) can be earthed. Disconnect them from the other wires and connect them with the earth cable of the unit. This gives the animal that tries to cross the wires an electric shock when it touches an earth and a hot wire in the same time. This is also effective if snow builds up and covers the lowest wires.

Large objects near the fence

Try to get large objects such as rocks, walls or other objects that can be used to climb into the enclosure as far from the fence as possible.

Time consumption and cost

The time needed to install a predator safe fence depends on the terrain and what facilities one can use. The use of a tractor equipped with a certain implement to knock down the poles reduces personal time consumption but increases the total cost. For a calculation of time consumption see table 1.

Tab. 1: Time consumption for two people to install an electrical fence with five wires. Time consumption is calculated for some kind of rather smooth terrain. It is also calculated for people who have previous experience on fence mounting. Time for preparatory work such as clearing away bushes and grass if necessary is not included.

Fixed time consumption		hours
Mounting of unit		0.5
Grounding	3 iron-bars	0.5
Gates	2 gates	1
Sum		2
Flexible time consumption (100 m)		hours
Mounting of refraction poles	2 poles	0.5
Mounting of wires		1
Mounting of in-between poles (16 poles, 1 minute per pole)		0.25
Mounting of insulators/ wire-holders (16 poles, 2 minutes per pole)		0.5
Sum		2.25

Tab. 2. Cost for two different kind of 4 km long fences.

	Electric fence with five wires	Sheep net supplied with two electric wires	Two extra electric wires (for already mounted sheep nets)
Total cost excluding energizer	3'400.- US\$	7'090.- US\$	1'940.- US\$
Cost per meter	ca. 1 US\$	ca. 1.8 US\$	ca. 0.5 US\$
Energizer and lightning conductor	640.- US\$	640.- US\$	640.- US\$

Note that the prices are very approximal (table 2). The sheep nets used in Sweden are actually more expensive than the electric fences. The sheep net of woven wires is more expensive and also a little harder to set up. It is, however, the standard sheep fence in Sweden. Most farmers already use them and therefore just have to supplement them with two electric wires to get a predator safe fence.

Common mistakes

1. Inadequate grounding
 2. Weak poles
 3. The poles are not knocked down properly
 4. The insulators are of a poor quality
 5. The lowest wire is too high off the ground
 6. Insufficient voltage because of leakage or resistance
- If the fence is too long for the unit's capacity the voltage becomes too low.
 - High resistance because of the material of the wires or bad splicing implies lower voltage.
 - Vegetation that leans over the wires or wires that get into contact with the sheep net cause voltage losses.

Conclusions

The fences are very efficient in keeping the domestic animals inside. They also provide effective protection against dogs and foxes. At least there have been no recordings of foxes crossing the fence. Since the fences have an elastic function they bend instead of breaking if i.e. a deer jumps into it. Deer and other wildlife quickly learn to avoid the fences. To maintain this effect the fences should be electrified all year round. The cost is small and the benefit greater.

The fences described in this article are mounted in different kind of terrains in Sweden. In some areas a drill must be used in order to get the poles as deep as recommended. The most difficult part is to get the lowest wires as close to the ground as 20 cm all the way along the fence.

The main problem with electric fences far from human settlement is theft since the equipment is quite valuable.

For technical details and special solutions contact an authorized retailer for electric fences. Some retailers (for example Lundex below) also provide

demo video tapes that show how the fences should be erected.

Links (most of them in Swedish)

AGRA Elephant fences

Telephone: + 46 19 31 41 65

E-mail: agra@oreline.net

The retailer speaks good English and has severe knowledge of electric fences.

Bole products

Telephone: + 46 652-747474

E-mail: bole@bole-produkter.se

<http://www.bole-produkter.se/>

L-G products

Telephone: + 46 456 303 31

E-mail: order@lgprodukter.se

www.lgprodukter.se

Lundex

Postadress: Box 142, 234 23 Lomma.

Besöksadress: Järngatan 35 Lomma.

Tel 040-41 88 80 Fax 040-41 88 88

E-mail: lundex@lundex.se

<http://www.lundex.se/>

Gallagher (English)

www.gallaghEurope.com

www.gallagher.co.nz/dynamic/index.cfm

www.gallagherusa.com

other links

<http://sureguard.com.au/fencedesign.html#high>

Electric Fencing for Predator Protection in Alberta

by

John Bourne; john.bourne@gov.ab.ca

Electric fencing and electrification of barrier fences began in Alberta nearly thirty years ago when Alberta Agriculture developed several electric fence designs to protect sheep from coyote predation.

During the development and research for a coyote-proof fence, Alberta Agriculture, Food and Rural Development (AAFRD) identified four essential components deemed essential to successful fence operation and performance: (1) minimal guard voltage, (2) critical overall fence height, (3) wire/mesh configuration and (4) ground return.

Several trial sites were located throughout the province to test the performance of various fence designs. All test farms currently experienced coyote predation on lambs or ewes at or exceeding the provincial average of 1.5% (of total flock size) and each test site had a minimum flock size of 100 breeding ewes with lambs at side. Also, during the entire twenty four month test period no other form of coyote protection was undertaken and producers maintained a detailed log documenting losses of all types.

All fence wires were 12.5 gauge (ca. 2 mm), high tensile strength, galvanized steel wire and the minimum enclosure size was 65 ha (160 acres). Many fence configurations were tested, however, the three designs that proved most successful were: (1) multi-strand seven wire, 55 inches (140 cm), (2) multi-strand nine wire, 54 inches (137 cm, Fig. 1) and (3)

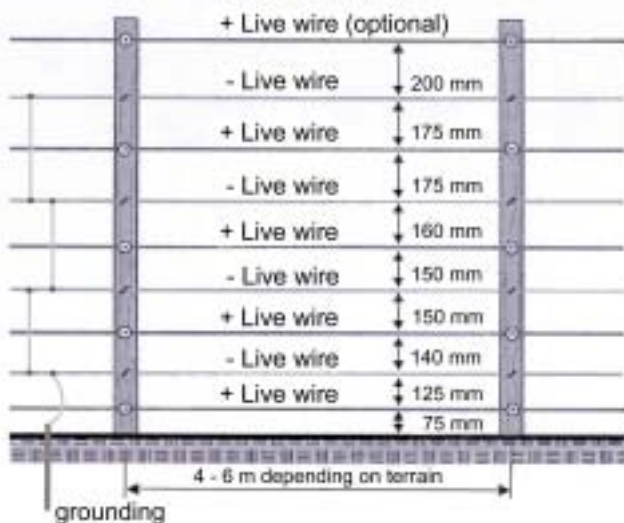

Fig. 1: Multi-strand nine wire fence (137 mm) with alternating charged and grounded wires.

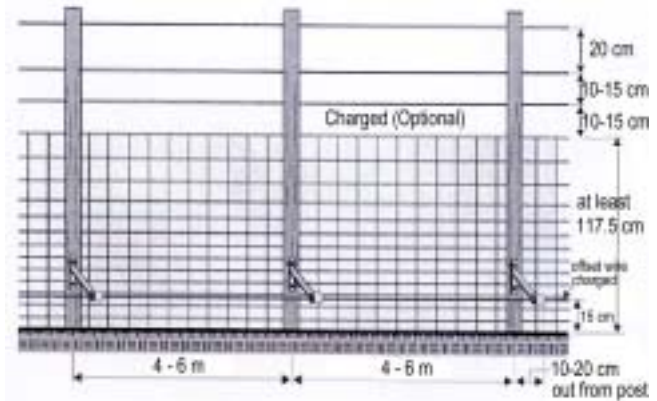

Fig. 2: An electrified, high tensile mesh-wire fence, viewed from outside the enclosure.

single outside off set wire on barrier mesh, 44 inches (112 cm, Fig. 2).

Through direct observation (and by communicating with other coyote researchers) AAFRD learned that over 80% of fence penetrations by coyotes (free choice) is accomplished by crawling under the lowest portion of the fence, next to the ground surface. The second choice of penetration (approximately 10-15%) is between ground level and shoulder height of the coyote (coyote does not leave its feet). Coyotes rarely jump over fences (<5%).

By using a metal replica of an adult sized coyote with approximately the same weight, body resistance to electricity, and contact surface area (of coyotes feet), AAFRD determined minimal guard voltage at approximately 3'500 volts to obtain 80% coyote repulsion on dry ground surface. All fence energizers were 110 volt plug-in.

The fence energizers first used in the trials were quite basic, very sensitive to lightning (and other power surges) with a very inefficient pulse output that resulted in poor performance beyond two - five km of fence. Today, fence energizers are equipped with powerful generating capacitance, low impedance and high voltage ratings of over 10'000 volt. Many multi strand fences with four or five hot wires can conduct 5'000 to 7'500 volt over 10 km of fence on 110 volt or 12 volt battery.

Also, many fence energizers on electric fences today are powered by a deep cycle 60 amp battery assisted by 130 to 150 watt solar panel to consistently produce 5'000 volt over a several km long fence.

Following two years of continuous performance, the seven strand multi-wire fence reduced coyote predation by 70%, the nine strand multi-wire fence

reduced coyote predation by over 80% and the off set single strand fence reduced predation by 65%.

The greatest problems in western Canada to fence construction and performance are post damage at corners, electricity drain due to "shorting out" caused by vegetation growth and other wire cross-over interference and inadequate grounding. High tensile steel wire (recommended tensile pull 85 kg) can cause severe corner post damage if line wire tension is not adequately adjusted (see tension adjusters) prior to onset of cold temperatures (i.e. colder than -15° C).

We recommend fence-lines be treated with a quick knockdown herbicide (i.e. glyphosate) prior to fence construction to reduce vegetation growth that will interfere with electricity flow.

Also, steel ground rods (2.0 - 2.5 cm diameter) need to be submerged three to four meters into the ground at each corner or every 0.5 km for adequate electricity return, during dry conditions in areas of light, sandy type soil.

AAFRD experienced only occasional wire breakage due to other wild life such as moose (*Alces alces*), white tailed deer (*Odocoileus virginianus*) or American black bear (*Ursus americanus*). Where large wild animals roam, fences should be flagged or identified to minimize accidental encounters.

The success of electric fences AAFRD developed has immensely benefited the livestock industry; in many cases producers altered fence designs/configuration to meet personal farm requirements and conditions. Nonetheless, the use of electricity has greatly improved the protection capabilities of Alberta livestock producers, particularly those whose property overlaps the natural occurrence of coyotes. Unfortunately, electric fencing is not for everyone and/or for every type of livestock operation; in those cases, other control strategies or agents must be incorporated into livestock management plans to prevent and control coyote predation.

AAFRD website:
<http://www.agric.gov.ab.ca>

Information on electric fencing on:
<http://www.agric.gov.ab.ca/agdex/600/684-7.html>

Electric Fencing and Carnivore Damage Prevention

by
Anton Vidrih; tone.vidrih@bf.uni-lj.si

Electric fencing is usually a well-accepted method for constraining livestock movements. It is fairly simple to use but it presents nearly no physical barrier, relying almost entirely on the fact that the animal receives a painful shock whenever it touches the fence. The goal of this article is to point out some remarks and ideas of what you have to note and what can help to achieve better protection of livestock against predators by using electric fences.

Carnivore damage prevention (CDP) fence

Livestock are easy to train to electric fences because they are calm animals, they usually have enough food and water on their pastures and they have learned to respect electric fences since the beginning of their life. Therefore, the motivation to escape is very low and they will stay on the same enclosure for several days. However, the fence must always be properly electrified. With predators the situation is quite different. They can penetrate the fence by accidental wandering, especially if the pen is located on traditional movement routes (e.g. bears). In the search for food predators have a higher motivation to try to penetrate the enclosure to get at the livestock. There are still very few electric fences designed for predator exclusion on a year round basis, decreasing the chance for large carnivores to be taught to respect electric fences. Moreover, livestock fences are usually switched off when livestock are not inside. Consequently, predators do not learn from the beginning to be fearful of electric fences, especially in areas where predators are recolonising. There are some basic rules when building the electric fence as well as conventional electric fencing for controlling livestock and electric fencing for CDP: design, visibility, high power, maintenance and training.

Design

The fence should be specifically designed to be predator-proof, especially adapted to increase the chance that the predator will receive its first electric shock through the head which is more severe than through other parts of the body. Like this, the electricity passes through the longer part of the body, increasing the effect. A fence will be tested continu-

ously, sometimes by the same animal or by new individuals that are roaming in the area. Fences for CDP must be set up with at least six wires, alternating the charges (-,+,-,+,-,+, etc.). The bottom wire should be grounded (earth return wire) and lying at only 10 cm above the ground. This wire should stop animals that attempt to crawl under fences (e.g. foxes). Like this, when it touches the second wire (live wire) while standing on the lower ground wire, good electric contact is made. This method will be particularly useful when the ground is very dry and may hinder conductivity to earth. But if the lowest wire is up to 20 cm above the ground, it should be positively charged to deter crawlers or diggers.

Predators that jump over the electric fence (e.g. wolves) seem to learn this with mesh wire fences (sheep fences) or similar non-electric fences. The height of the fence is the only limit for jumpers. By adding a supplement fence in front the first one to enlarge the whole system, a jumper will hesitate to leap over. It is also possible to bend (over-hang) the fence towards the direction from which the animal approaches. These kinds of fences definitely give better predator exclusion than simple vertical ones. They seem to deter the predator from jumping over or from pushing through. But vertical fences are much more easy to construct and maintain. Offset wires can be used to achieve the same benefits of the angled fence without the associated construction, and in some cases, maintenance problems. The use of appropriately designed, galvanised spring-steel wire offset brackets are easily attached to existing fences and are flexible to withstand animal pressure. One or more offset wires, on the side from which the predator will approach, improves the exclusion ability of electric fences. If only one is used, it should be positioned at 2/3 rd of the height of the predator.

For large carnivores, because of the insulation of their thick fur, wire tension must be increased and maintained at 180 kg, especially on bottom wires. Permanent tension springs can be fixed on each line, and wire tension must be checked frequently. The wire should be at least 2.5 mm thick. Thinner wire reduces the visibility, conductivity, and life of the fence.

Snow and frozen ground can greatly reduce the effectiveness of the earth return system. If the electric fence is not in use during wintertime, all lines should be set down on the ground to be covered by the snow. Like this predators will not encounter an ineffective fence and learn how to cross it. The fence lines should be set up and electrified early enough before the return of the flock to the protected pas-

ture, to teach predators to avoid such fences. In fact, fences should always be electrified. If they are not, the wires should lie on the ground or be removed.

Visibility

The fence will not stop a large animal that runs through the fence without even seeing it. Moreover, most contacts with electric fences occur at night. Therefore, the fence must be visible. The visibility of electric fences can be improved by adding ranks of wires and increasing the number of stakes, or by tying fluttering things on the wire, such as aluminium twists or spins. Light reflective material is best. The fence line must be well cleared from the side that predators approach to stop them and to get them investigating the fence in a slow and cautious manner. Good visibility of permanent wires in electric fences is achieved if white electric tape (polytape) is mounted on offset brackets on the fence from the predator approaching side. Such polytape can be set on the top of the fence to increase its height. Maintaining the visibility of the fence is part of the maintenance work.

High power

Trials with different domestic and wild animals have shown that a low powered shock does not deter animals from repeatedly testing the fence. Some animals can become accustomed to a low powered shock and learn to ignore it, with disastrous results. At least 4'500 volts should be maintained on all wildlife fences at anytime, with pulses around one per second. We must make sure the newly constructed fence is turned ON before securing for the night. The first contact must be a memorable event. The total length of the wires determines energizer choice.

The new generation technology makes power fences much more available, effective, reliable and easy to maintain. Features for managing smart and high power fence system include:

- Remote control to switch the energiser on/off from anywhere on the fence for the maintenance work on the fence
- Performance indicator lights or digital displays
- Monitors and alarms to warn of poor system performance
- Adapted control that automatically adjusts the output to suit fence conditions
- Replaceable modules for easy servicing
- Built-in lightning protection to help protect the energizer from extreme damage

Maintenance

Maintaining the fence visibility is part of the maintenance and animal training programme. Electric fences are not maintenance free. Each component should last for the expected life of the entire fence. The different prices between the most expensive item and the cheapest one does not affect significantly the total cost of the entire fence. If using inferior materials the CDP fence will not be effective for a very long time. Once the fence is erected, continual maintenance is very important. The fence must be periodically checked. The electric power must also be checked regularly with the help of a voltmeter or control light (live light) hanging on the fence, which tells you through a flash if it is still working. A yearly check of the earth system of the energiser is also required.

Training

The whole idea of predator training is to get them to investigate the fence in a slow and cautious manner, in order to get the first shock on the nose. If the shock is delivered to the back of the head, animals often react by lunging forward rather than backing up. There are several ways to help a predator to raise its nose on the fence. Baits (chicken wings) can be hung up on the live wire on the fence. There is no need that the predator grabs directly the bait, it is enough if it put its nose close enough to it. The strength of the first shock will often determine how the animal is going to react to the fence in the future.

Conclusion

If we want to develop sustainable farming practice (improving the soil fertility, maintaining or increasing biodiversity, paying attention to maintain clean water and air) then we need the domestic herbivores to help us to reach this goal. But this can only be achieved if we are able to protect domestic animals in an effective way against large carnivores. Permanent electric fencing costs so little and it is so easy to build up that we should spend enough time and buy material of good quality to do the work well. Otherwise there will be many reasons that the fence will not serve to its purpose. Our ability to think and develop new ideas to prevent carnivore damage is the only limitation that the electric fencing has.

Operation of Power Fences: Some Practical Advise

by
Agnès Dhilly

The following is a quick overview of some of the most important elements associated with the use of electric fences.

How does an electric fence work?

An electric fence stops animals because of the fear of an electric shock. Therefore, the most important thing in a electric fence is electrification.

For a better circulation of the electricity, the resistance R1, R2 and R3 - resistance of the conductor, of the surrounding factors, and of the soil - have to be as low as possible.

R1 – the conductor

Only the wires should be responsible for the transport of the electrical current. The other parts of the fence (e. g. poles) have to be insulated (fibreglass, plastic). However, the wires have a resistance R. Use of a good alloy, wires with a sufficient diameter, and several parallel wires in a fence all contribute to reduce the resistance.

R2 – resistance connected to the environment

Any contact with vegetation will increase the resistance. It is linked with the number of wires and is therefore smaller in fences with just one wire (cows, horses...) than in fences with 3-5 wires (sheep, goats...) with wires in contact with the vegetation. Keeping fences vegetation free will require constant maintenance.

R3 – resistance of the soil

The grounding is a crucial point for an effective electric fence (see Fig. 1). The resistance connected to the grounding system has to be as low as possible (0 Ohm). First of all the quality of the grounding is dependant on the type of soil.

Depth of the grounding system: Place at least 3 galvanized rods of 1-2 m length at a distance of 3 m from each other into the soil.

Stony soil: Look for a crack in the rocks!!, or try to spread the grounding system over a large surface (e.g. galvanized grid).

To insure that the circuit is complete and that the current is going back to the energizer (aggregate), the contact between the grounding system and the soil should be as high as possible. This is very important for both the efficiency of the system and for the amount of pain

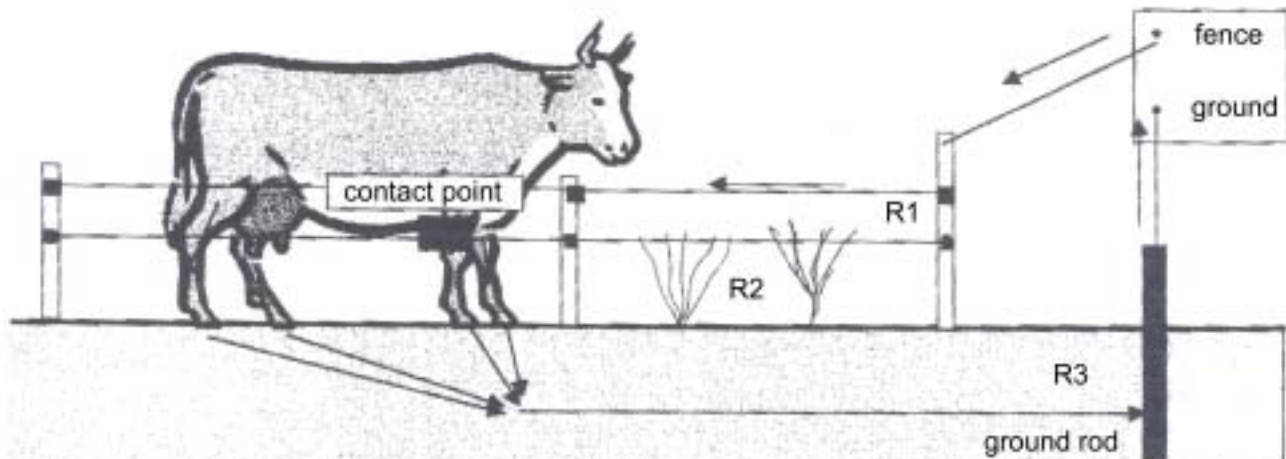

Fig. 1: Circulation of electric current in the fence.

felt by animals that touch the wires. For a simple test of the whole system, you can measure the volts with a voltmeter on the grounding rods. It should be as low as possible, ideally 0 Volts but less than 300 Volts is ok (if you touch the rods you don't feel anything).

To improve the grounding system in a dry season or in dry soils the rods can be regularly doused with water or you can use bentonite to improve the conductivity and keep the soil around the grounding rods wet. Under extremely dry conditions one of the wires can be directly connected to the ground. This will provoke a short circuit if the animal is touching one of the wires (fence and soil).

The energizer

The principle of an energizer is to increase the initial tension -12V or 220V up to several thousand volts - and to transform the direct or alternative current into an electric impulse.

There are three types of power sources (220 Volt and 12 Volt):

1. Battery (12 V)
2. Solar (12 V)
3. Mains supply (220 V in most European countries); with and without a compensator.

The compensator estimates the resistance of the fence system and adapts the amount of energy that is needed for an adequate impulse.

The resulting impulse is of no danger to humans. The voltage required to deter cows and horses from passing the fence is about 2500 Volts. For the less sensible sheep a minimum current of 4000 Volts is needed. For excluding large carnivores a higher voltage is needed (see accompanying articles).

Installation of an electric fence system

There is a minimum of maintenance for an electric fence system. To keep this work as low as possible there are some important principles:

- Build an open circuit: in an open circuit you know the starting point and the end of the fence. This will allow you to control the current at the two extreme points. So you will find the source of loss very quickly. In a closed circuit it is almost impossible to find the loss.
- To be able to do quick controls of the fence you should isolate long electric fences in sections.
- Check the joins between the wires: use the same steel in order to avoid oxidation that will prevent the current from passing (rust is an insulator!).
- Connect the energizer with conductors through the air so you have a better control of the system.
- The same thing for the barrier: make sure that the ends are not electrified while open. Connect the two ends of the fence at the barrier also with a conductor via air.

The electrification of a fence is a question of methodology. If it's respected, the maintenance is very easy and it will stop the animals from passing.

Problems and Limitations of Electric Fences

- Inadequate earthing
- Bad or corroded connections on the earth return or live wires
- Long and thin wires
- Long distances of single wire fences
- Rusty wires, rusty earth poles
- Untrained animal standing on dry insulating soil or stone and touching only the live wire
- Leakage through poor insulation or excessive vegetation growth on the fence

Contact:

Agnès Dhilly, Innov'Action Pastorale,
Fargues; 46330 Cabrerets, France
Tél. +33 (0)5 65 31 29 90; Fax. +33 (0)5 65 30 23 71

Fence systems and Grounding Systems: some practical advice

by
Christof Angst; ch.angst@kora.ch

There are two different types of electric fence systems: the *all live system* or *ground earth return system* and the *earth return wire system*. They should be used in different conditions as follows:

All live system or *ground earth return system*

This system has all the fence wires "live" (Fig. 1) and the circuit is completed when the animal touches one of the wires. The electrons then flow through the animal into the ground and back to the energizer. This system should be used where there is relatively even rainfall and where there is some green vegetation most time of the year, or in areas with high conductive soils. *The all live system* has much lower maintenance requirements than the *earth return wire system*.

Earth return wire system

The *earth return wire system* (Fig 2) overcomes the problem of dry non-conductive soils, not allowing sufficient current to flow back to the energizer or making contact with animal feet. The fence should have live and earth wires. By touching both live and earth wires on the fence, the animal receives the full shock. The earth wires should be connected to a number of ground pegs at every kilometer approximately. Connect the ground (neutral) wires on the fence to the main ground using insulated cable.

These secondary ground rods also help to give

protection against lightning damaging the energizer and they assist in eliminating shocks on gates through the current taking an alternative route. This system has the disadvantage of requiring a high standard of construction and maintenance because if the live **and** earth wires come in contact through faults, the fence is ineffective.

Your grounding system must be perfect!

Without any grounding system, the pulse could not complete its circuit, so it would be completely ineffective and there would be no shock on the fence. The grounding system of the energizer is like the antenna of a radio. The bigger the antenna, the better the reception. The same is true for electric fences: a high powered energizer requires a large grounding system to collect the large number of electrons from the soil. Soil is not a good conductor so the electrons spread out and travel over a wide area.

Dry soils have a very high resistance so if possible, choose an area which is damp all the year.

In areas with highly conductive moist soil all year round, three two meter long, 25 mm in diameter, galvanised pipes or galvanised ground rods driven into the ground 3 meters apart should suffice (see earth rule in the box below).

Ensure that they are at least 10 meters from any power supply earth peg, underground telephone or power cable!

- Thinly electroplated items soon rust and then create resistance. They should NOT be used.
- Where the wire from the energizer to ground rods

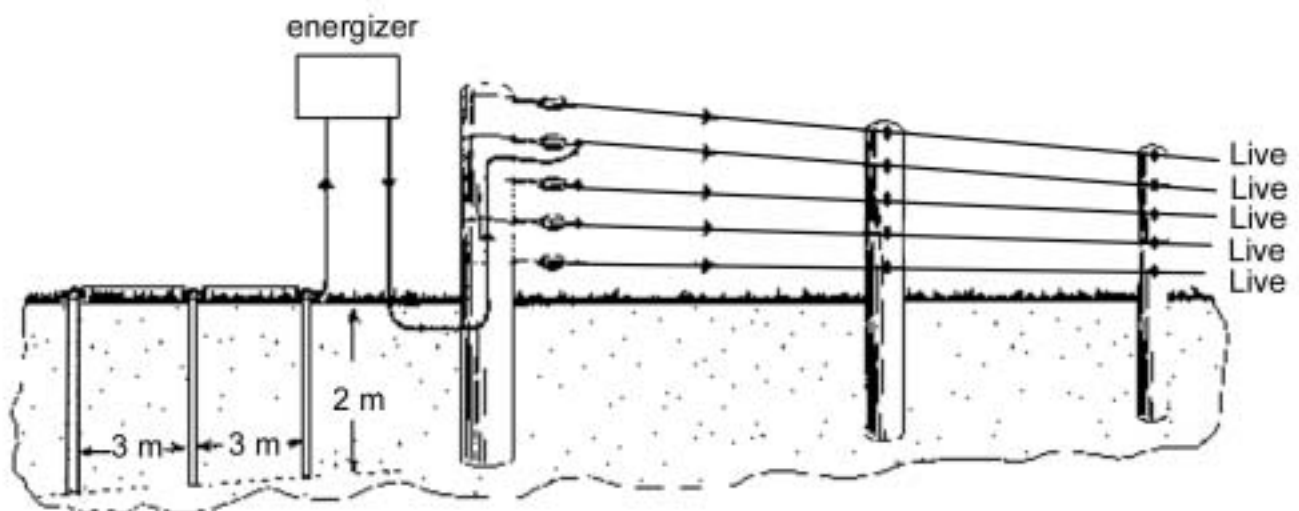

Fig. 1: Scheme of a all live system or ground earth return system.

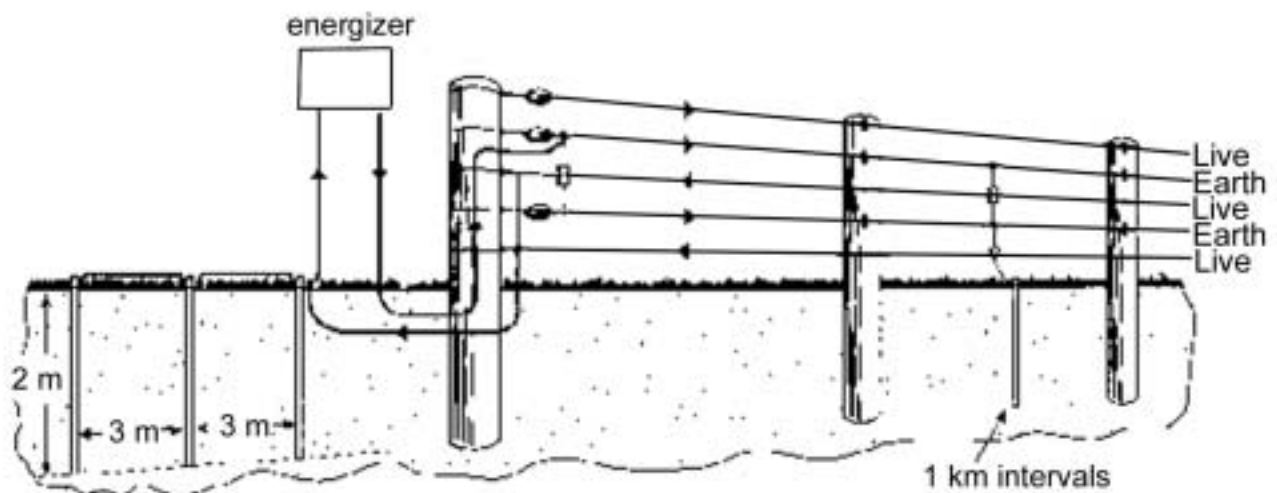

Fig. 2: Scheme of an earth return wire system.

is likely to come in contact with soil, yards, water-pipes or buildings, use insulated cable.

In soils which dry out severely and have a low mineral content, an absorbent clay and salt system should be used. Salt is highly conductive and also attracts and holds moisture. Trials by Gallagher have shown a ten fold improvement by using this system.

Earth Rule 1 2 3 3

- 1 = One continuous wire to join pegs
- 2 = Galvanised earth pegs must be two meters long
- 3 = Minimum of three 2 m pegs
- 3 = Minimum of three meters between pegs

Testing the ground system

If your fence is not giving the shock you expect, it is most likely to be your ground system. Always check the ground first. The ground is half the effective circuit in an electric fence system.

The main causes of an ineffective ground are:

- Insufficient ground rods
- Badly connected wires or wires of different metal types joined together
- Poor connections to the ground rods
- Ground rods too close together
- Ground rods not long enough

Depth is important to good grounding as it ensures that part of the ground rod is always in damp soil.

Testing the ground earth return system (see Fig. 3)

1. Test the current in a distance of 100 m from the energizer. There should be at least 4000 Volts (No 1 in Fig 3).
2. Create a dead short by placing enough steel stakes against the fence line to reduce the voltage to 1000 volts or less. These stakes should be at least 100 m from the ground system (No 2 in Fig 3).
3. Connect one clip from your digital voltmeter to the last ground rod. Connect the other clip to a small stake placed in the ground at least 1 m from any other ground rods (No 3 in Fig. 3)
4. The reading on the voltmeter should be 0.3 kV or less. If it is greater than this, the ground system is inadequate and more ground rods will be need to be added.

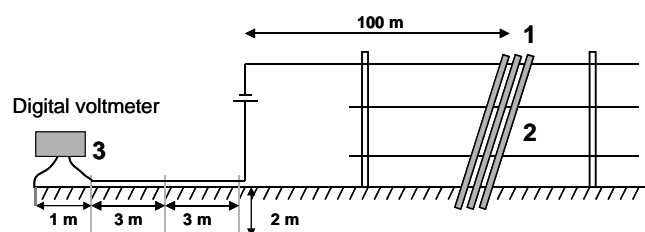

Fig. 3: Sketch of how to test a ground earth return system.

Some important points to remember when setting up an electric fence

Wire joints

Incorrectly joined wires can be a major cause for power leakage. When joining wires in the middle of a fence, use joint clamp. They cost almost nothing but help to improve the functionality of the fence enormously. If you have to do a knot, use either a *figure eight knot* or a *reef knot* (Fig. 4). Never join the two ends of the wires with a simple knot. You lose too much energy (the resistance can be equal to one kilometer of wire).

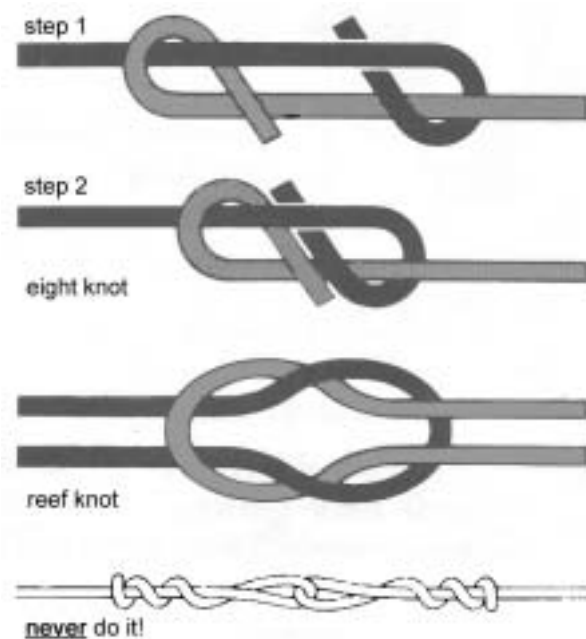

Fig. 4: Knots you should use to joint wires in the middle of a fence and knots you must never use.

Marking high voltage fences

You must clearly mark these high voltage fences with warning signs so that people don't walk into them or touch them. Young children can be severely hurt or even killed if they touch the fence with a vital part of their body (e.g. neck when trying to crawl under the fence). Providing clearly marked crossing points with stiles or gates will be vital for long fences in heavily trafficked areas.

Diameter of wires

Use at least 2 mm wires. The bigger the diameter, the better the conductivity, the more powerful the whole system. Two wires together will halve the resistance and three will reduce it to only 1/3.

Problems and limitations of electric fences

There are several factors that can have a negative influence on your electric fence system resulting in a reduced output:

- Inadequate grounding system
- Bad or corroded connections on the earth return or live wires
- Long lengths of thin wire
- Long distances of single wire fences
- Rusty wire
- Untrained animal standing on dry insulating soil or stone and touching only the live wire
- Leakage through poor insulation or excessive vegetation growth on the fence
- Broken wires

Faults to look out for

If there is no electricity in the wires or only a little, check the following things:

- Is the energizer switched on?
- Is the leadout wire connected to the energizer and the fence line? Is there a break in the leadout?
- Is the earth wire connected to the energizer and ground rods?
- Is there a break in the ground?
- Is there a dead short on the fence line?
- Are there any faulty or broken insulators?

Always check the voltage at the energizer first.

To check if the energizer is faulty, disconnect both the leadout and the ground wires and test the energizer without any load. If the energizer is reading below the manufacturer's specification there could be a fault with the energizer.

Check the grounding system according to the description above.

If no fault is discovered with either the energizer or the ground system, check the fence line.

The use of a digital fence tester (see Marketplace on p. 18) makes the job of finding faults enormously easier.

The readings will continue to drop until you reach or pass the fault. After the fault, the readings should remain constant (remember there may be more than one fault).

New publications

Musiani, M.; Visalberghi, E. 2001. Effectiveness of fladry on wolves in captivity. *Wildlife Society Bulletin*, 29(1).

The technique known as fladry, traditionally used to hunt wolves (*Canis lupus*) in Eastern Europe and Russia, consists of driving them into a bottleneck formed by 50 X 10 cm red flags hanging from ropes stretched over the ground. The technique also has been used to live trap wild wolves. The aim of our study was to assess whether five captive wolves living in two enclosures (120 m² and 850 m²) also responded to fladry. We found that avoidance was maximal when flags were < or = 50 cm apart and their base was at ground level. In these conditions, wolves never crossed red flags (or grey flags of the same brightness) intersecting their usual stereotyped routes (baseline: 4.08±3.11 SD trespasses/min), even when the daily food ration was placed on the other side of them. In contrast, trespasses occurred when inter-flag distances were > or = 75 cm or rope heights were < or = 25 cm or > or = 75 cm. Wolves bit at the uncrossed barriers significantly more than the crossed ones (P<0.02). Our results indicated that: 1) fladry is effective on captive wolves and 2) fladry can be used to confine wolves into limited spaces and to prevent them from accessing food, at least for a brief time. Our study provides additional evidence that this technique has potential for wolf management and to protect livestock from wolf depredation..

Allen, L. R.; Sparkes, E. C. 2001 The effect of dingo control on sheep and beef cattle in Queensland. *Journal of Applied Ecology*, 38(1): 76-87.

Predation by dingoes *Canis lupus dingo* is regarded as a widespread problem by Australian livestock producers. This study examined five decades of historical data to evaluate the use and effect of dingo control on the distribution of sheep and beef cattle in Queensland. 2. In Queensland, dingo bounties were significantly more numerous in years with high sheep numbers but significantly less numerous in years with high beef cattle numbers. These relationships probably reflected the social and economic attitudes of the two producer groups to dingoes. 3. The relatively high impact that dingoes are perceived to have on sheep compared with beef cattle, the control techniques used by the two producer groups, and the intensity at which these techniques are applied,

were the underlying causes. 4. Subsequent to the introduction of baiting using 1080 (sodium fluoroacetate), there was an immediate decline in the use of strychnine, the number of dingo bounties presented for payment, and the number of dingo trappers employed by local governments in Queensland. However, these changes were confounded by a simultaneous decline in sheep numbers and dingo control effort. 5. Barrier fences and poisoned 'buffers' were compared for their ability to protect sheep from dingo predation. With few exceptions, sheep numbers declined or increased marginally within 50 km inside a dingo barrier fence or within a boundary between sheep and beef cattle production outside the dingo barrier fence. This contrasted to areas >50 km from the dingo barrier fence or sheep/cattle boundary. 6. Both poisoned buffers and barrier fences could be equally effective at preventing sheep losses. However, buffers are best suited to open arid areas where large-scale co-ordinated baiting programmes are more feasible and where prey scarcity leads to increased bait consumption. We predict that sheep production outside the dingo barrier fence in Queensland will contract from the north and east. There is a case for re-establishing a barrier fence in this area to prevent such contraction. 7. Coordinated predator management, such as barrier fencing or aerial baiting, can protect sheep at a regional level. However, unless the financial burden of pest control is shared through a centralized scheme, sheep producers living along the boundary are likely to leave the industry or substitute cattle for sheep and the sheep-production area will contract. 8. This paper cautions the use of bounties as a measure of relative abundance and illustrates how people's perception of a pest and the type of livestock they produce can affect their level of control effort and the control methods they use.

Rigg, R. 2001. Livestock Guarding Dogs: Their Current Use World Wide. IUCN/SSC Canid Specialist Group Occasional Paper No 1; pp 133.

Although livestock guarding dogs (LGDs) have been used in Eurasia for millennia to protect domesticated animals from wild predators, stray/feral dogs and human thieves, the 2001 study Livestock guarding dogs: their current use world wide reports a decline in many countries for several reasons. Some regional varieties, such as those of Afghanistan and Iran, may no longer exist, while several others are rare and/or endangered, e.g. Portuguese breeds and Bulgaria's Karakatchan. These and others more com-

mon, at least in their country of origin, have been bred for show, as pets, property guardians or misused which may have weakened their livestock protection capabilities; crossbreeding is another threat found to adversely affect the guarding abilities of some breeds. The changing economics of livestock husbandry also has an impact.

On the other hand, a new role for LGDs has emerged in recent decades: helping to conserve the very carnivores against which they were developed to guard! Because LGDs are one of the most effective non-lethal methods of reducing predation, their use is especially appropriate for livestock protection when rare, threatened, endangered and legally protected species are causing the damage. Many large carnivore conservation initiatives therefore include LGD projects, as in Slovakia, Poland, France, Switzerland and Portugal. There have also been trials in countries where there are no native breeds and their use is not traditional, such as Norway, sometimes with very successful results, as in Namibia and, most notably, the USA, where LGDs have become so widespread and well-studied that knowledge gained there is assisting LGD revival or introduction projects elsewhere. When these efforts provide funding and assistance to farmers, they offer a way to off-set the initial economic costs and difficulties of raising pups to be livestock guardians and hence can ensure that the use of livestock guarding dogs continues to be a (cost) effective option.

In addition to providing an introductory guide to the use of LGDs and the various traditional breeds, the report also reviews data on livestock predation from a variety of countries in Africa, North America, Asia, Australia, Europe and the Middle East. In the majority of countries studied, the author found evidence that LGDs help reduce predation on livestock, in many cases quite dramatically. A range of factors appear to affect the level of success, from animal husbandry methods to the breeding and raising of the dogs. Producers in the USA have found that LGDs can offer a range of other advantages such as reduction in human labour, greater piece of mind, more efficient use of pastures and potential expansion of flocks.

Livestock guarding dogs: their current use world wide by Robin Rigg, University of Aberdeen and the Slovak Wildlife Society, was published as an occasional paper by the IUCN/SSC Canid Specialist Group and can be downloaded from <http://www.canids.org/occasionalpapers>

Marketplace

Fence tester:

An easy way to find faults: **PATKON** Electric Fence Power Probe®:

simple to use - on touch operation

- Leads you quickly to the fault in the fence
- Clearly indicates the direction of the fault
- Digital reading shows the voltage and current

Price: ca. US\$ 80.-

www.pakton.com.au/

Smartfix

Pinpoints faults quickly and easily whatever the wire type or energiser used. By simultaneously measuring the current flow and voltage, the Smartfix will follow the current flow to any one of a series of faults. A necessary tool use on a electric fence from single wire to more complex multi-wire installation.

Price: ca. US\$ 90.-

www.gallagher.co.nz

For more information on electric fencing and the little things that help you to simplify your work, please contact the manufacturers on the web or the websites mentioned in the articles:

Manufacturers:

www.gallagher.co.nz

You can order the *Power Fence™ Manual* via their website (in English, German, French and Dutch). There is a lot of helpful information included.

www.kiwifence.com/

www.maxflex.com/

www.kencove.com/add.htm

www.kencove.com

www.electric-fence.net

www.cheetah.ie/

This list does not claim to be complete. Please search the web for further manufacturers.

Information and tips on electric fencing, grounding etc.:

www.kencove.com

www.agric.gov.ab.ca/agdex/600/684-7.html

www.foothill.net/~ringram/groundng.htm

www.sureguard.com.au

www.safefence.com/EF_Theory.htm

www.wvu.edu/~exten/infores/pubs/pest/deer819.pdf

www.ibiblio.org/farming-connection/grazing/features/ground.htm#Poor

As well as the manufacturers list, this list is not complete. Please search the web for further information.

Meetings of interest

July 14-19, 2002

"Human-carnivore conflict. Local solutions with global applications"

Canterbury UK

For details see:

<http://www.ukc.ac.uk/anthropology/dice/scb2002/>

July 28 to August 3, 2002

„Living with Bears“

Steinkjer, Norway

For details see:

<http://www.hint.no/bearconference/index.shtml>

or contact:

Ole Jakob Sorensen:

Phone: 47-74 11 20 52

e-mail: ole.j.sorensen@hint.no

Tor Kvam:

Phone: (47)74 11 21 19

fax: 47-74 11 21 01

e-mail: tor.kvam@hint.no

October 17-20, 2002

2. International Canid-Symposium

D-51429 Bergisch Gladbach (near Köln), Germany

For details see:

<http://www.hundeschule-ab.de/Hundefarm/wolfsymp.html>

or contact:

Gabriele Huber, Am Graben 3, D-50259 Puhlheim,

Phone and Fax: 0049/2234/8 96 97

e-mail: Canids2002@aol.com

Dezember 5-6, 2002

Symposium on „Sustainable Coexistence“ with carnivores

London Zoo, Great Britain

For details please contact:

Rosie Woodroffe

e-mail: rosiewoodroffe@aol.com

April 6-9, 2003

10th Wildlife Damage Management Conference.

Date:

Location: Clarion Resort on the Lake, Hot Springs, Arkansas

Information: not yet available

December 1-5, 2003

3rd International Wildlife Management Congress

Location: Christchurch, New Zealand

Information: To receive a first announcement brochure, contact:

3rd IWMC, Conference Office, Centre for Continuing Education, University of Canterbury, Private Bag 4800, Christchurch, New Zealand.

e-mail: wildlife@cont.canterbury.ac.nz

www.conference.canterbury.ac.nz/wildlife2003

Tel. + 64 3 364 2915

Fax + 64 3 364 2057

Damage prevention on the Web

Predator FAQ

www.members.home.com/18james/rural/predator.html

Reports on several different prevention measurements

Damage Prevention and Control

www.conservation.state.mo.us/manag/coyotes/control.html

Wildlife Solutions Online

www.wildlifesolutionsonline.com/carnivores.htm

A lot of pdf-files about all sorts of wildlife damage

Wildlife Damage Links

www.aphis.usda.gov/ws/nwrc/wildlife_damage_links.htm

The internet Center for Wildlife Damage Management

<http://wildlifedamage.unl.edu>

A lot of pdf-files available

The Berryman Institute for Wildlife Damage Management

www.berrymaninstitute.org

Predator defense Institut

www.enviroweb.org/pdi/alternat.htm

Flock & Family Guardian Network

www.flockguard.org

Reports on different breeds of livestock guarding dogs

Working Dog Web

www.workingdogweb.com/wdbreeds.htm

A lot of information on guarding dogs with links to other webpages

Livestock Gurarding Dogs

www.lgd.org

Llamapaedia

www.llamapaedia.com/uses/guard.html

Provides information about llamas as guarding animal

Bear Biology

www.bearbiology.com

National Wildlife Research Center

www.aphis.usda.gov/ws/nwrc/

Vertebrate Pest Conference

www.davis.com/~vpc/welcome.html

Conditioned Taste Aversion page

www.conditionedtasteaversion.net/

Carnivore Conservation

www.carnivoreconservation.org/

A huge number of links

How to get Carnivore Damage Prevention News:

There are three ways to receive CDP News:

1. As a paper copy by mail¹⁾
2. By e-mail as a pdf-file
3. Download as pdf-file from the LCIE website (www.large-carnivores-lcie.org/) or the KORA website (www.kora.unibe.ch)

Please order CDP News from the editorial office by e-mail: cdpnews@kora.ch

CDP News on the Web

The CDP News can be downloaded as PDF file on:

- LCIE-homepage:
www.large-carnivores-lcie.org
- KORA-homepage:
www.kora.unibe.ch

CDP News on www.kora.unibe.ch offers the following service:

- Download CDP News as pdf-file
- Database with information about CDP-specialists
(If your coordinates on the web are not complete, please send details to cdpnews@kora.ch)

Impressum:

Editorial: Ch. Angst, J.-M. Landry,
J. Linnell, U. Breitenmoser

Editorial office:

KORA
Thunstrasse 31
3074 Muri b. Bern
Switzerland
e-mail: cdpnews@kora.ch
Phone: ++41 31 951 70 40
Fax: ++41 31 951 90 40

Financially supported by LCIE (Large Carnivore Initiative for Europe).

We welcome the translation and further distribution of articles published in the CDP News under citation of the source.

The responsibility for all data presented and opinions expressed is with the respective authors.

LCIE card



The Large Carnivore Initiative for Europe aims

"To maintain and restore, in coexistence with people, viable populations of large carnivores as an integral part of ecosystems and landscapes across Europe".

According to this mission statement, the LCIE defines four important fields of activity:

1. conservation of large carnivore populations and their habitats;
2. integration of large carnivore conservation into local development of rural areas;
3. support for large carnivores through appropriate legislation, policies and economic instruments;
4. the human dimension (information and public awareness with the aim of obtaining the acceptance of large carnivores by all sectors of society).

To solve the conflict arising from the predation of large carnivores on livestock, the prevention of damages is of high priority. For more information on the LCIE please visit the LCIE website (www.large-carnivores-lcie.org) or contact the LCIE coordinator, William Pratesi-Urquart (wpratesi@csi.com).

Contributions desired

Dear subscribers,

The CDP News will only thrive with your active participation. Articles should be as „down to the earth“ as possible. Please send us any contribution on the following topics:

- Prevention measures
- Prevention measures that did not work
- Statistics on damage
- Compensation systems
- Technical articles
- Problem animal management
- Opinion and forum papers

¹⁾The financial support by the LCIE allows us to distribute the CDP News for free. However, to minimise postal taxes, we prefer distribution by e-mail wherever possible.